



## Installation Instructions - iTroll Generation 2 Control Head and Power Module

### STEP 1:

Install the servo motor and throttle linkages from the FIT KIT into your motor that iTroll will be controlling. The fit kit has specific instructions for the motor it was designed for. **Make sure that you have performed the servo ROTATION and TRAVEL programming sequence in the fit kit instructions for your particular boat motor(s)!** When fit kit install is finished, go to Step 2 below.

### STEP 2:

Find a location in the battery compartment to mount the power module - See Fig. 1. The requirements for this location are as follows:

1. Close enough to 12V battery to allow Red power lead and Black ground lead to be connected to it.
2. There must be a flat surface to mount the power module to with double stick tape or supplied screws. **If using screws, consider what is BEHIND this surface prior to drilling into it!**
3. Another way to mount the power module is to lash it to an existing harness with included cable ties.
4. The 10 foot long grey servo harness must be run into the power head of outboard motor that iTroll is controlling or to servo location on inboard motor that iTroll is controlling.
5. Grey harness with oval 3 pin connector is for the second servo in dual motor setups.



**Power Module Mounting  
Figure 1**

### STEP 3:

Mount power module. If using double stick tape, clean mounting surface with supplied alcohol pad and let it dry before sticking power module on. If temperature is below 70 degrees, warm mounting surface with a blow dryer to insure best bond strength.

### STEP 4:

Connect Red wire to **+12 VOLT** battery terminal or UNSWITCHED (live at all times) fuse panel. 5 amp fuse has been installed at factory. Connect Black wire to (-) battery terminal.

### STEP 5:

**NOTE: Keep servo harness as far away as possible from spark plug wires and do not let it rest directly against areas of motor that get hot.**

- If iTroll will be controlling a SINGLE motor, run servo control harness described in Step 2.4 into the power head of the motor you installed the fit kit on. Plug servo into iTroll's harness. Note that iTroll's 3 pin connector has a polarizing "DOT" on it. This dot corresponds to the servo's signal wire that is Orange, Yellow or White, depending on the brand of servo.
- If iTroll will be controlling DUAL motors, run the servo control harness described in Step 2.4 into the power head of the KICKER motor and servo control harness described in Step 2.5 into power head of the MAIN motor. Plug servo into iTroll's harnesses. Note that iTroll's 3 pin connectors have a polarizing "DOT" on them. This dot corresponds to the servo's signal wire that is Orange, Yellow or White, depending on the brand of servo.

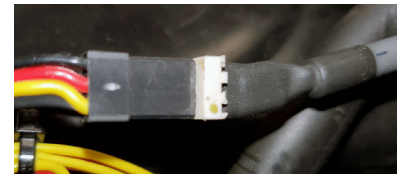

STEP 6: Neutral Safety interfaces: Uses thin (22 Gauge) BLUE & YELLOW wires from power module.

If using iTroll on a "T" handle remote shift and throttle motor(s), you may want to install neutral safety interface(s) (sold separately) so that iTroll will go to idle whenever the shifter is put in neutral. iTroll can recognize two neutral safety interfaces. The BLUE wire is for the interface for motor 1, the YELLOW wire is for the interface for motor 2.

### STEP 7:

iTroll's data cable from the power module joins to the control head's data cable with our weatherproof cable union. This allows the control head to be removed from boat to prevent theft. The union may need to be removed to allow you to run the data cable in the boat. See Fig 2 on how the union works. **Put union in a location (under dash board or in storage compartment) that is not exposed to rain or spray.** The union is weather-proof when fully assembled, but if left unassembled when the control head is removed, water can reach the internal contacts of the data cables.

### STEP 8:

Use supplied cable ties to give the installation a professional appearance.

### STEP 9:

Mount iTroll control head. Some owners do not mount the control head as they like to move it about the boat. If not mounted, secure control head when you operate boat at speed.

- Use supplied Velcro strips to secure iTroll to any hard surface. Clean mounting surface and back of iTroll with supplied alcohol pad and let dry before applying Velcro.

**CAUTION: When using iTroll, make sure data cable is managed at all times to prevent it from becoming a tripping hazard!**

**Data Cable Union / CABLE STOPPER:**

**Note:** When iTroll is shipped, there is a stopper installed in the cable union. This stopper keeps the union weatherproof when iTroll's control head is unplugged. Use of the stopper is **VERY IMPORTANT** so that the contacts of the union stay dry and don't corrode. The stopper can easily be stored when the data cables are connected together by hanging it on the data cable.

**Cable Union ASSEMBLY VIDEO:**

<https://www.youtube.com/watch?v=sTaH01Ngqko>



**Cable Union Install Notes**

Secure union so it sits horizontally (see UP arrow).

Tighten end caps so there are **NO gaps at these locations**

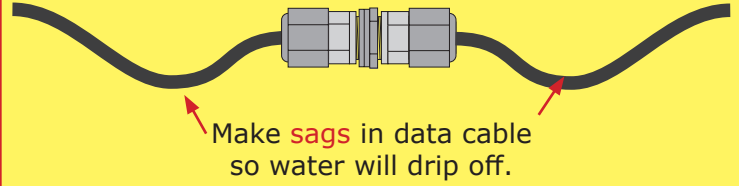

The cable union assembly is made up from a center connector, two cable grippers, two seals and two end caps. To assemble:

1. Thread data cable through end cap.
2. Install seal on data cable. Seal has slit in it for easy installation.
3. Thread data cable through cable gripper.
4. Plug data cable into center connector.
5. Tighten cable gripper over center connector - **FINGER** tight only!
6. Slide seal into "fingers" of cable gripper. When properly installed, seal should **NOT** stick out from the fingers of the cable gripper.
7. Tighten end cap over cable gripper - **TO INSURE WEATHERPROOFNESS, MAKE SURE THERE IS NO GAP BETWEEN END CAP AND CABLE GRIPPER!**
8. Repeat for other side.

To remove control head, simply reverse above steps on the side of the union that hold the control head's data cable.

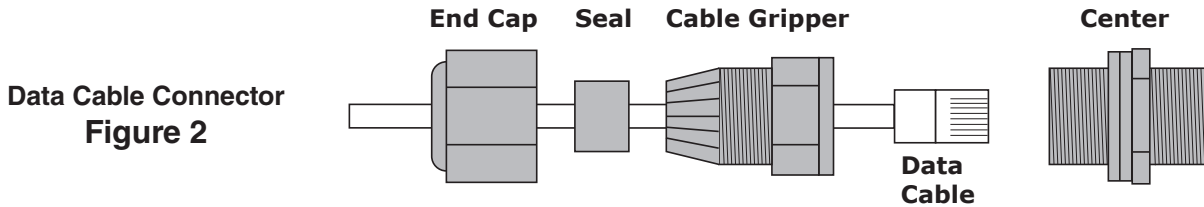

**Control head dual location option:**

Use optional extra data cable and cable union (both sold separately) to allow you to use iTroll at the helm or rear of the boat for varying fishing situations:

iTroll's cable system allows the greatest versatility and cleanest routing for safety! Use of an optional additional 20 foot data cable and additional weatherproof connector allows iTroll to be used in multiple locations while minimizing the tripping hazard that a loose cable presents.

- = iTroll Control Head
- = iTroll PM (Power Module)
- = Weatherproof Connector
- = Data cable from Control Head
- = Data cable from Power Module

Note: Power Module mounted in battery compartment, excess data cable from power module bundled to control it's length.

— = Optional Data Cable Run **INSIDE** Storage Area

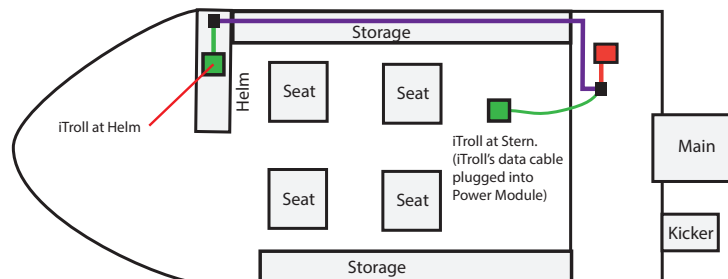

iTroll at Helm: Data cable that runs through gunnel (purple in diagram) connects Power Module and iTroll control head together.

iTroll at Stern: 5 foot data cable from iTroll control head connected directly to Power Module.

## Remote Idle / Run Switch Wiring:

Please note that these switches are optional and must be purchased separately!

A new industry first feature of the Generation 2 iTroll is the ability to place remote mounted pad switches anywhere in the boat that work EXACTLY like the Idle / Run button on the iTroll control head. This allows you to control iTroll from multiple locations. There is NO limit to the number of switches that you can install. Let your imagination run wild!

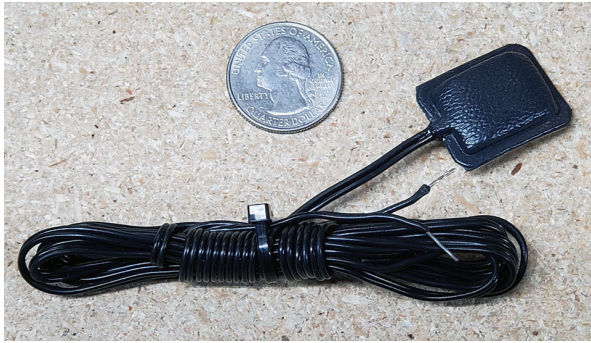

Remote Idle / Run Switch



Gunnel mounted switch - wire hidden behind grab handle

When mounting switches, choose locations that will not allow for accidental operation of a switch. For instance, mounting a switch where a tackle box might be placed on top of it or stepped on is NOT a good location.

Wiring these switches is very easy. The switches simply connect the BROWN wire from the power module to ground. If you want to install more than one switch, simply duplicate the hook up for the switches in this diagram:

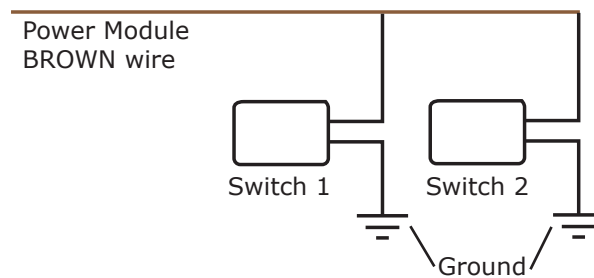

## Reference 1: Kicker steering unit interfacing:

It is best to contact the manufacturer of your steering unit for specific instructions on how to interface it with iTroll. iTroll's steering outputs are intended to drive RELAYS only (the relays then power the steering unit). iTroll's steering wires put out a +12 output that is capable of supplying a maximum of .25 Amps.

iTroll's RIGHT (Starboard) turn wire is the RED one from the power module  
iTroll's LEFT (Port) turn wire is the GREEN one from the power module

If the manufacturer of your steering unit is unable to help you with the interfacing with iTroll, please seek out a qualified boat mechanic to perform the interfacing for you. Use the following schematic as a guideline with steering units that use a reversing DC (direct current) motor:

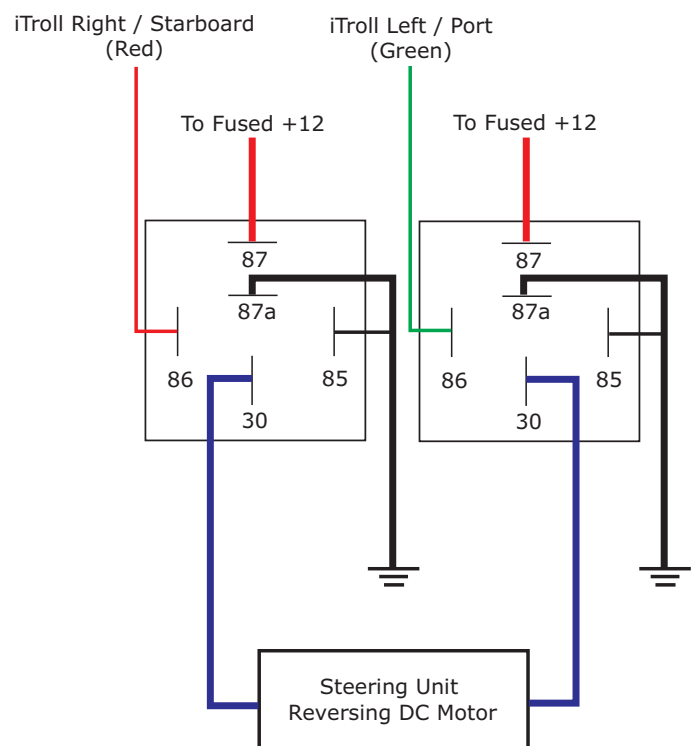

## Reference 2: Changing Servo Travel and Rotation

iTroll has the unique ability to allow you to program both the TRAVEL and ROTATION direction of the servomotor(s). Additionally, when dual motor enabled, iTroll remembers independent travel and rotation values for each servo! This gives iTroll the ability to be compatible with any servo on the market and to be installed on the greatest variety of motors. Specific details for servo travel (90, 135 or 180 degrees) and rotation (Clockwise or Counter-Clockwise) are specified in iTroll's fit kit instructions. To set servo rotation and travel, follow the steps below:

**Note:** When given the same positional commands, some servos rotate in the same direction (when increasing throttle) as iTroll's dial (clockwise) and others counterclockwise. Please test the rotation direction of your particular servo before reprogramming.

**DISCONNECT** servo arm (or disc) from servo's shaft prior to reprogramming the servo's travel or rotation! This insures that the throttle linkages will not jam the servo when it repositions itself after programming!

R2.1: Start with iTroll OFF. If your iTroll is NOT Dual Motor enabled (an optional software upgrade), SKIP to Step R2.6.

R2.2: Determine the motor that you are setting servo parameters for (1 or 2). Turn iTroll ON. (Please see owners manual).

R2.3: When the screen to access "Options Menu" appears, press the Hunt button. Select the motor that you want to change the servo's parameters on. Let iTroll finish starting up.

R2.4: CONFIRM that the number in the upper left corner of iTroll's display matches the motor choice you made in Step R2.2 above.

R2.5: Turn iTroll OFF

R2.6: The menus to reprogram servo travel and rotation are accessed through iTroll's digital padlock. This prevents the parameters from accidentally being changed.

R2.7: Enter the combination of 3, 8, 33, 88 into the padlock with the method below:



iTroll's screen will read "Lock #1"  
• Turn dial so second line reads "3"  
• Press the Hunt button

Repeat steps above to enter remaining combination numbers of 8, 33 and 88 into the padlock.

When a correct combination is received, iTroll will show a screen to allow servo travel and rotation to be changed.

R2.8: For your reference, iTroll displays both the previously programmed servo travel AND the new one you are selecting. Change new servo travel by turning iTroll's dial. Servo Travel values:

"S" = 90 degrees  
"M" = 135 degrees  
"L" = 180 degrees

Note: iTroll OEM specified servos (HiTec D645 / D646WP) must have special programming downloaded into them at the iTroll factory to allow them to travel 180 degrees.

When desired travel is displayed, press the Hunt button to store value.

R2.9: For your reference, iTroll displays both the previously programmed servo rotation AND the new one you are selecting. Change new servo rotation by turning iTroll's dial. When desired rotation is displayed, press the Hunt button to store value.

R2.10: iTroll will turn OFF. Turn iTroll back ON, wait for startup procedure. Put iTroll in idle mode by pressing IDLE button and reconnect servo arm.

